

Installation, Operation Maintenance Instructions For 8500 Series Control & Isolation Butterfly Valves

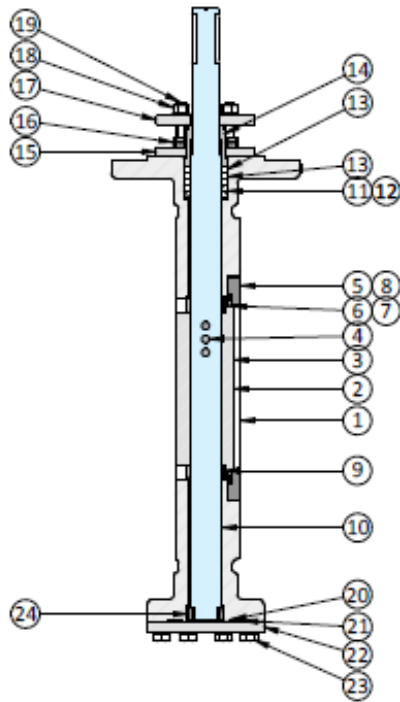

Figure 1: Severn 8500 Series Control Valve – Cut section view.

20	Cover end o ring
21	Cover gasket
22	Cover Plate
23	Cover end bolts
24	Anti Blowout nut

GENERAL INSPECTION OF PARTS

GLAND PACKING (ITEM 13) – Not re-useable. Note that higher-pressure valves may have gland arrangements at both ends of the stem (pressure-balanced design)

COVER END GASKET (ITEM 21) (AND COVER END O RING (ITEM 20) IF FITTED) – Not re-useable.

Maintenance items are: 2, 6/7, 9 and 10

Advanced Inspection – (to be carried out by trained/experienced personnel only)
SEATS - Not re-useable

GASKETS (Body / Seat - if fitted) - Not re-useable

DISC – If damaged, contact Severn for advice on repair or whether replacement is needed.

BEARINGS / SPACERS - Examine for general condition and renew if necessary.

SEAL RETAINER - Check general condition. Renew if needed.

INTENDED USE

Reference is to be made to the Valve Specification / Data Sheet, Installation and Operation Instructions, and nameplate to check the product is suitable for the intended use/application.

Table 1:

ITEM NO.	DESCRIPTION
1	Body
2	Disc
3	Shaft
4	Taper Pin
5	Seat Retainer
6&7	Seal ring
8	Retainer Cap screw
9	Disc Spacer
10	Bearings
11	O Ring Carrier *1
12	O Ring
13	Gland Packings
14	Gland Follower
15	Gland Plate
16	Lock Nut
17	Gland Plate
18	Gland Nut
19	Gland Stud

		SEVERN GLOCON VALVES PRIVATE LIMITED. F-96697, SIPCOT IND. PARK, CHENNAI 602 117, INDIA	
SERIAL No.	<input type="text"/>	TAG No.	<input type="text"/>
ORDER No.	<input type="text"/>	BODY MATL.	<input type="text"/>
SERIES	<input type="text"/>	YEAR MFG.	<input type="text"/>
TRIM MATL.	<input type="text"/>		
SIZE	<input type="text"/>	RATING	<input type="text"/>
LEAKAGE CLASS	<input type="text"/>	TRAVEL	<input type="text"/>
PORT SIZE	<input type="text"/>	ACT MODEL	<input type="text"/>
SUPPLY PRESS	<input type="text"/>	SIGNAL	<input type="text"/>
CV/CHAR	<input type="text"/>	SPRING RANGE	<input type="text"/>
AIR FAIL	<input type="text"/>		
MAX. ALLOW. PRESS. & TEMP.	<input type="text"/>	M. N. ALLOW. PRESS. & TEMP.	<input type="text"/>
<small>Read manufacturer's instructions prior to installation and use</small>			

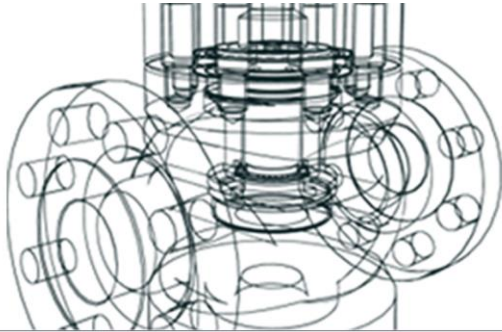

Installation, Operation Maintenance Instructions For 8500 Series Control & Isolation Butterfly Valves

A sample nameplate is shown above, showing maximum and minimum pressure/temperature. Notified body number is applicable for PED only.

Safety: Always ensure safe working practices are followed:



Always ensure a safe working environment when lifting



Always isolate the valve before maintenance. Always use lockout methods to ensure safety.



Caution: The valve may be extremely hot or cold.
Caution: Do not put your hands inside the valve



Always use the correct tools. Do not over-tighten. Do not use extension bars to force movement.



Poison risk: Do not incinerate PTFE. Do not smoke whilst handling PTFE.



Always read the manual. If any doubts exist, contact Severn quoting the valve serial number.

WARNING: When ordered, the valve configuration and materials of construction are selected to meet particular pressure, temperature, pressure drop, and fluid conditions. Personal injury, property damage, equipment damage, or leakage due to escaping gas or bursting of pressure-containing parts may result if the valve or its ancillaries are over-pressured or installed where service conditions exceed the valve design limits. To avoid such injury or damage, provide a relief valve for overpressure protection as required by accepted industry or local codes and good engineering practice. Do not apply other conditions to the valve without written approval from Severn.

WARNING: Before performing any maintenance operation: Isolate the valve from process pressure.

Relieve process pressure from both sides of the valve. Drain the process media from both sides of the valve. If the valve is to be removed from the line decontaminate any process fluid remaining in the valve to make it safe. Disconnect and isolate any operating lines providing air pressure, electric power, or a control signal to the actuator. Vent the air pressure from the actuator. Be sure that the actuator cannot suddenly open or close the valve (Note by disconnecting the air and/or power lines the actuator will move the valve to its power failure position). Ensure persons are at a suitable distance from moving parts. Use lock-out procedures to be certain the above measures stay in effect for the duration whilst work is carried out on the valve.

MACHINERY DIRECTIVE 2006/42/EC INCORPORATED INTO A MACHINE

Severn valves must not be put into service until the machinery into which they are to be incorporated has been declared in conformity with the provisions of the Machinery Directive. Severn valves must not be used as Safety Components (Emergency Shutdown Valves) within the meaning of the Machinery Directive without prior notification to Severn.

ATEX DIRECTIVE 2014/34/EU

Under the ATEX Directive, a risk assessment is necessary by the end user to justify the basis of safety.

PRESSURE EQUIPMENT DIRECTIVE PED 2014/68/EU

It is a requirement of the PED that both the maximum and minimum working pressures and temperatures of the valve are recorded on the nameplate. Refer to the actual nameplate attached to the valve and the Severn Control Valve Specification or Valve Data Sheet (CVSS or VDS) issued with the valve to check the valve is suitable for its intended use. Attention must be paid to the combined pressure and temperature characteristics of the appropriate valve material group as stated in ASME B16.34, API 6A, or relevant international standards.

Note: Butterfly valve nameplates may be fitted to the bracket as opposed to the valve. Take care to match the serial number on the valve to the serial number of the nameplate if the valve is being rebuilt after a full strip down.

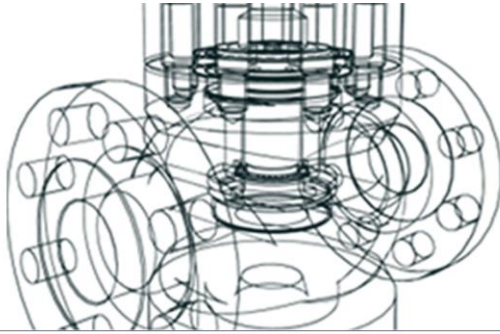

Installation, Operation Maintenance Instructions For 8500 Series Control & Isolation Butterfly Valves

Reference is to be made to the Valve Specification / Data Sheet, Installation and Operation Instructions, and nameplate to confirm product suitability for the application.

If any doubts exist, contact Severn quoting the valve serial number.

SCOPE OF THIS MANUAL - INSTALLATION - GENERAL

This manual includes installation, operating, and maintenance information for butterfly valves. Please refer to separate manuals for instructions covering the actuator, positioner, and any accessories. Where the valve is operated by pneumatic, electric, hydraulic, or electrohydraulic actuation, follow the IOM instructions provided with the actuator.

Where the valve is operated by a gearbox, follow the instructions provided with the gearbox.

Only persons qualified through training and or experience should install, operate, and maintain this product. In case of questions about these instructions or the valves please contact the nearest Severn office before proceeding.

Instructions in the following paragraphs describe the installation procedures for the valve. Instructions not included are to be performed in accordance with standard industry-acceptable practices as may be required by local codes, specifications, and or regulations. Users should refer to BS 6683 "Guide to installation and use of valves".

STORAGE

Unless specifically specified by the contract, the valve will have been packed for indoor storage at the job site.

For short-term storage, the valve should be installed in a fire-resistant weather-tight, and well-ventilated building. The valve should be kept at a temperature of -20F (-29deg.C) to +120F (48deg.C). The area should be constructed and situated so that it will not be subjected to flooding; the floor should be similarly level, firm, protected, and well-drained. Valves should be on pallets or shoring to permit air circulation.

For longer storage, a corrosion preventative should be considered that is compatible with the process fluids. Further advice should be sought from Severn.

HANDLING

Applicable codes regulations and industry practices must be followed when handling or lifting valves. Care should be exercised to protect instrumentation and ancillary equipment. Severn lifting guidelines are available on request.

FLUSHING

The valve will have been cleaned at the factory and sealed for despatch with protective covers. However, before installing the valve inspect the valve body cavity to ensure, it is free of foreign matter, dirt, grit, etc.

When the valve is to be installed in a system suspected to be contaminated, the system should be flushed to prevent damage to the valve trim. It is recommended this be done before installation of the valve or if not possible; special flushing trims should be purchased from Severn.

IMPORTANT

High-temperature valves are designed with expansion clearances to allow operation at above 300°C. Flushing of valves at ambient temperature must be with clean water only. If significant particulate is present in the line, a flushing valve or spool is recommended. For high-temperature designs where solids are present, contact Severn, as specialist design may be required.

INSTALLATION

The valve should preferably be installed in a straight run of pipe away from bends or sections of abnormal velocity and by general ISA guidelines. The preferred orientation is with the stem horizontal across the valve body. Other orientations may be used but care should be taken, particularly if the service is not clean.

Make sure that actuators are supported appropriately. The weight of large valve assemblies should be taken into consideration when mounting in the pipework and pipe supports may be required on either side of the valve.

For uni-directional valves, the flow through the valve must be in the direction indicated by the flow arrow plate on the valve (damage to the trim, and actuator and sudden movement of the valve may result from flowing in the wrong direction). Bi-directional valves may have a flow arrow fitted if there is a preferred

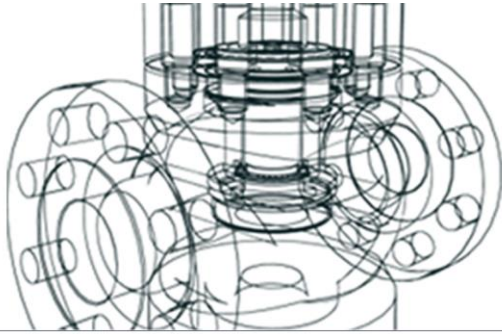

Installation, Operation Maintenance Instructions For 8500 Series Control & Isolation Butterfly Valves

direction. It is recommended that flow through the valve is in the direction indicated in such cases. Use accepted piping practices when installing the valve. Use a suitable gasket between the valve and the pipeline flanges.

All valves operating above 150 deg. C must be installed with suitable insulation covering the valve and mating flanges to minimize the risk of high differential expansions that may cause damage to the valve.

PRE-OPERATION

The valve gland was tightened before shipment; however, the packing may require some adjustment to meet specific service conditions before being put into service. It is normal to expect adjustments to be made before putting into service.

For actuated valves, connect the correct utilities to the valve and check all accessories, e.g. positioner, etc. are correctly set. If fitted, the positioner must be set to close and seat the valve correctly to avoid any premature trim degradation. If a manual hand-wheel override is provided in the actuation system, ensure this is in the disengaged or neutral position. Clean the actuator shaft of any foreign matter.

Check bolting in case of loosening. Re-check after the first heat cycle. Tighten evenly by going from opposite bolt to opposite bolt in line with the recommendations as laid out for tightening sequence patterns in ASME PCC-1-2010, appendix F. Caution: Always use correct tools for bolting including the use of torque wrenches to ensure bolts are not over-tightened during any checks carried out.

OPERATION

In operation, ensure that the valve operates smoothly and that there is no juddering or unusual motion. If the valve exhibits any strange behaviour, please contact your nearest Severn representative immediately.

IMPORTANT

For all actuator / Gearbox adjustments refer to relative IOM instructions. If any doubts exist, contact Severn quoting the valve serial number.

MAINTENANCE

Butterfly valve parts are subject to normal wear and tear and must be inspected and replaced as necessary. Inspection and maintenance frequency depends upon the severity and importance of the service. This section covers instructions for maintenance that can be carried out with the valve in the line.

Whenever a valve is disassembled, it is mandatory that all consumable parts must be replaced before re-assembly. Consumable parts are considered as all soft parts with the addition of the metal seal if fitted. This metal seal may be of solid, laminate, or hybrid seal construction.

Severn takes great care in its selection and quality control in meeting all manufacturing requirements (heat treatment, dimensional tolerances, etc.). Use only genuine replacement parts supplied by Severn.

Gland Packing Maintenance (this section not applicable to PTFE FE type, which does not require tightening)

A minor leak in the gland packing (item 13) may be stopped by adjustment of the gland nuts (item 18). Gland bolting may be adjusted by loosening lock nuts (if fitted) and tightening each primary nut evenly until the packing is firm. Take care not to over-tighten as this may provide excess friction and could reduce valve performance. Where locking nuts are provided these may now be re-fitted. Take care to lock the primary nuts correctly without affecting any prior packing adjustment that may have been made.

If the gland packing is relatively new and tight on the valve stem and tightening the gland bolt nuts does not stop the leakage, the valve stem or the bonnet housing may be worn or scratched. Replacement packing should be considered with an examination of the valve stem and body bore.

Recommended torque for tightening Butterfly valves Seat Retainer (8500 OCT)

Cap Screw Size	Torque (Nm)
M6x1	5
M8x1.25	14
M10x1.5	28

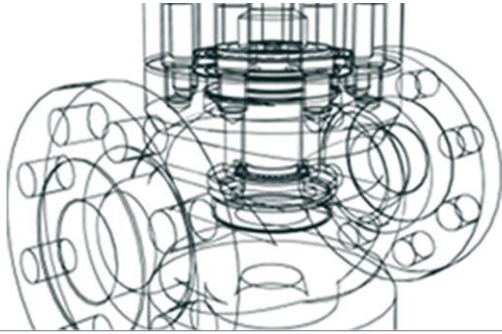

Installation, Operation Maintenance Instructions For 8500 Series Control & Isolation Butterfly Valves

M12x1.75	49
M16x2	124
M20x2.5	242
M24x3	419

REMOVING THE GLAND PACKING

Ensure the valve is not pressurized. Remove the gland plate (item 17) A groove is machined on the outside of the gland follower (item 14) to allow a screwdriver to be used to prise the gland follower loose. Remove gland packing (item 13); a packing extractor tool may be required to dig out the packing. If a packing extractor tool is used take great care not to damage any surfaces on the valve stem or the valve body bore.

Clean the gland-packing body bore and other metal parts. Scratches and burrs that could cause gland leakage or damage to new parts must be removed by light emery cloth or if this does not remove the defect replace the damaged parts. Inspect the parts for wear or any other damage that would prevent proper operation should these parts be reused. Gland packing arrangements should always be replaced with new, genuine Severn spare parts.

IMPORTANT

In certain cases, full removal of the packing set may only be possible as part of a larger valve disassembly. Such operations should only be carried out by qualified personnel. Additional instructions for this work are available by contacting your nearest Severn office.

Pending their condition and if fitted, it is recommended that stem gaiters are also replaced at the same time as packings, as both require access to the stem area. These are an optional spare.

Packing Types

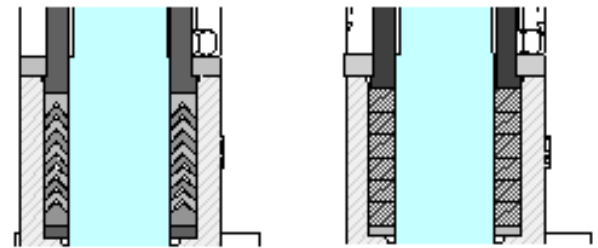

PTFE Packing

Graphite Packing

Notes:

1. Stuffing box design is common irrespective of packing type/ model
2. Low emission PTFE & Graphite based packing will be provided for Fugitive Emission application

STANDARD GLAND PACKING MATERIALS ASSEMBLY

Use the correct cross-section of gland packing or die-formed gland packing rings to fit the assembly. Install one ring of gland packing at a time. Make sure it is clean and has not picked up any dirt in handling. Seat each gland packing ring firmly (except PTFE filament and graphite yarn packing, which should be snugged up very gently, then tightened gradually after operating the valve a few full strokes). Joints of successive rings should be staggered and kept at least 90 degrees apart. Each ring should be seated with a tamping tool or suitable split bushing to the gland stuffing box. After the last gland packing ring is installed tighten the gland bolts finger tight.

Do not jam the packing into place by excessive gland bolt loading. Operate the valve several times to set the packing. Re-tighten the gland a little after each full cycle until no noticeable drop-off in bolt torque is noted. Ensure that the gland flange is central and at 90 degrees to the valve plug stem. Re-fit locking nuts/half nuts if provided.

For Graphite yarn gland packing, tighten the gland flange nuts alternately in small equal increments until an initial compression of the gland height of 30% is reached. For a 6 ring 0.15-inch uncompressed square packing set this would equal $6 \times 0.15 \times 0.3 = 0.27$ inch

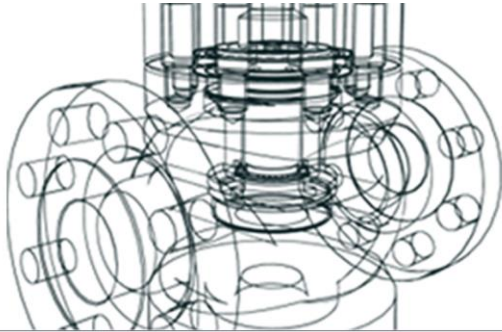

Installation, Operation Maintenance Instructions For 8500 Series Control & Isolation Butterfly Valves

Stroke the valve 3 to 5 full cycles and retighten as above. Ensure that the gland flange is central and at 90 degrees the valve plug stem. Re-fit locking nuts/half nuts if provided.

GRAPHITE LOW EMISSION FE, GLAND PACKING SET

Install the gland packing set one ring at a time. A braided ring is fitted first followed by the shaped rings. Fit these rings in the correct direction with the top braided ring last. Compress the gland packing set to a distance of 1 packing cross section. Check the torque on the gland nuts to establish a reference torque. Actuate the valve stem 3 or 4 full cycles. Check the gland nut torque and restore to the original reference value. Repeat the full stroke and re torque steps above at least 3 times until no significant amount of stud nut torque decay is noted after valve stem cycling. Ensure that the gland flange is central and at 90 degrees to the valve plug stem. Re-fit locking nuts/half nuts if provided.

OCT-SW PACKING SET

Install the O rings carefully onto the O ring carrier. Fit the O ring carrier over the stem and into the bore of the body taking care not to catch the O rings during fitting. Evenly push the O ring carrier down to the bottom of the packing bore. The graphite part of the packing can then be fitted in the normal way described previously.

NOTE: This information should be used as a guide only as each manufacturer of gland packing has its specific installation instructions that should be followed. For other

gland packing types see individual specialized packing instructions.

NON-DRIVE END GASKET REPLACEMENT

Where valves are fitted with a dual gland arrangement, fit the second gland as per the drive end. Where valves are fitted with a Cover plate (item 22), again making sure there is no pressure inside the valve, the plate may be removed by undoing the Cover end nuts (item 23).

Following removal of the Cover end plate the gasket or gasket and O ring (depending on valve design) may be removed and the area should be cleaned carefully.

Once clean a new gasket (& O ring if required) may be fitted and the Cover end replaced and the Cover end nuts re-tightened. Tightening should be carried out in such a way as to ensure an even force is applied via an appropriate tightening sequence.

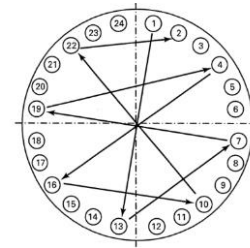

24-bolt example of tightening sequence as per ASME PCC-1-2010, Appendix F

ENVIRONMENTAL LEGISLATION & IPPC DIRECTIVE 2008/1/EC

All companies have an impact on the environment and as such are morally and legally responsible for managing these effects. Environment legislation has been developed over time to ensure any impact stays within acceptable limits. Legislation tends to be complex and constantly changing.

The European Union defines the obligations with which highly polluting industrial and agricultural activities must comply. There are now several EU Directives of direct relevance. The Integrated Pollution Prevention and Control (IPPC) Directive 2008/1/EC establishes a procedure for authorizing these activities and sets minimum requirements to be included in all permits, it requires the Best Available Techniques (BAT) for minimizing pollution for various industries. Also, be aware of the European Pollutant Emission Register (EPER) under the umbrella of the IPPC Directive which may also impact the operation of the product.

Valves, permanently installed by professionals in a large-scale stationary industrial machine or system consisting of a combination of equipment/components, each of which is manufactured to be used in industry only, are explicitly excluded from the scope (Article 2) of Directive 2012/19/EU (WEEE). They are consequently also excluded from the scope (Article 2) of Directive 2011/65/EU (RoHS).

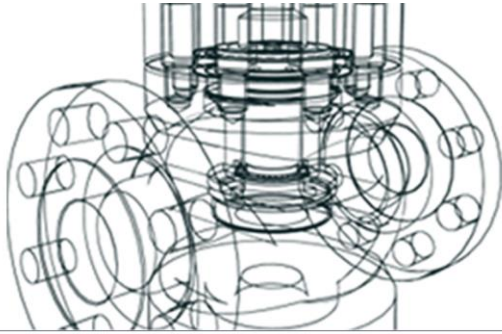

Installation, Operation Maintenance Instructions For 8500 Series Control & Isolation Butterfly Valves

WARNING: HEALTH & SAFETY AT WORK ACT

Gland packing and/or internal seals made of or containing PTFE (Polytetrafluoroethylene) should not be incinerated. Do not smoke whilst handling PTFE.

DISPOSAL

Unless otherwise stated in the Installation and Maintenance Instructions, this product is recyclable, and no ecological hazard is anticipated with its disposal providing due care is taken.

RETURNING PRODUCTS

Customers are reminded that under EC Health, Safety and Environment Law when returning products to Severn, they must provide information on any hazards and the precautions to be taken due to contamination residues or mechanical damage which may present a health, safety or environmental risk. This information must be provided in writing including Health and Safety data sheets relating to any substances identified as hazardous or potentially hazardous.

Note: This manual is to be read in conjunction with Severn's "Supplementary Installation, Erection, Maintenance, and Operating Procedures" document number DS610, specific conditions of use (SCofU) any other related O&M instructions relating to any accessories fitted to the Valve.

If any other maintenance work is required, please contact an approved service center for a quotation.

Disclaimer: Neither Severn or any of its affiliated entities assumes responsibility for the selection, use, or maintenance of any product.

Responsibility for the proper selection, use, and maintenance of any product remains solely with the purchaser and the end user.

The content of this publication is presented for information purposes only, and while every effort has been made to ensure accuracy, they are not to be construed as warranties or guarantees, express or implied, regarding the products or services described herein on their use or applicability. We reserve the right to modify or improve the designs or specifications of such products at any time without notice.

SEVERN CONTACT DETAILS

Severn Glocon Valves PVT Limited (Unit 1)

F96/97, SIPCOT Industrial Park,
Irungattukottai, Chennai:602117, India
T: +91(0)44 67102300 / 67102800

Severn Glocon Valves PVT Limited (Unit 2)

A-50, SIPCOT Industrial Growth Center,
Oragadam, Chennai:602105, India
T: +91(0) 44 67123200

Severn Glocon UK Valves Limited

Olympus Park, Quedgeley,
Gloucester GL2 4NF, United Kingdom
T: +44(0) 845 223 2040

Severn Aberdeen

Unit E, Badentoy Avenue Badentoy Park,
Portlethen Aberdeen, AB12 4YB
T. +44 (0) 1224 780 036

Severn Qatar

Madina Group PO Box 24462
Street No. 44/45, Salwa Industrial Area Doha, Qatar
T. +971 (0) 4460 0818

E: sales@severnvalve.com
marketing@severnvalve.com

W: www.severnvalve.com

Document Version: 8500-1.0/06/2024