

5000 Series Control Valves

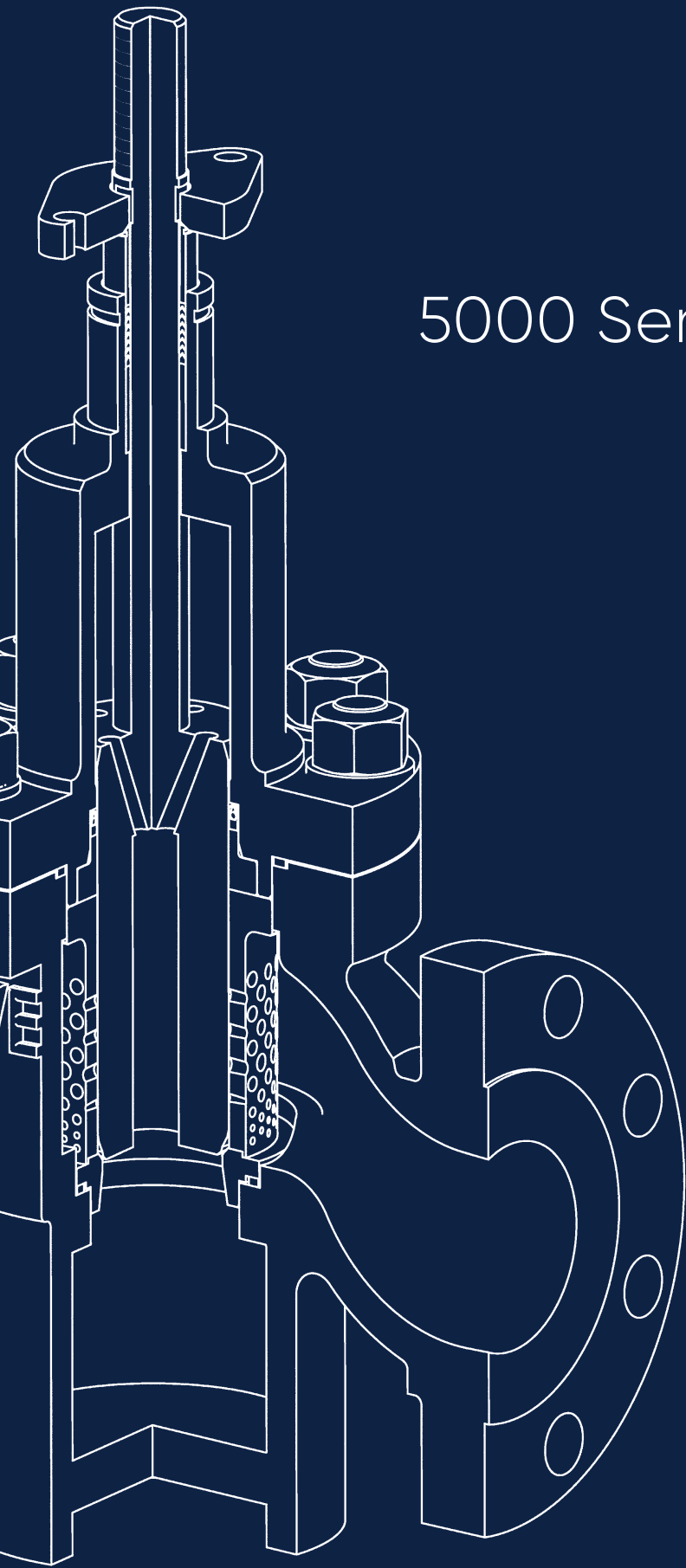

It all flows from expertise.

Contents

5000 Series Control Valves overview	01
Design features & performance benefits	02
Engineering data	02
Valve body style option	04
Bonnet options	04
Standard trim options available	05
Trim designs	07
Flow coefficients (Cv)	07
Standard dimensions & weights	08

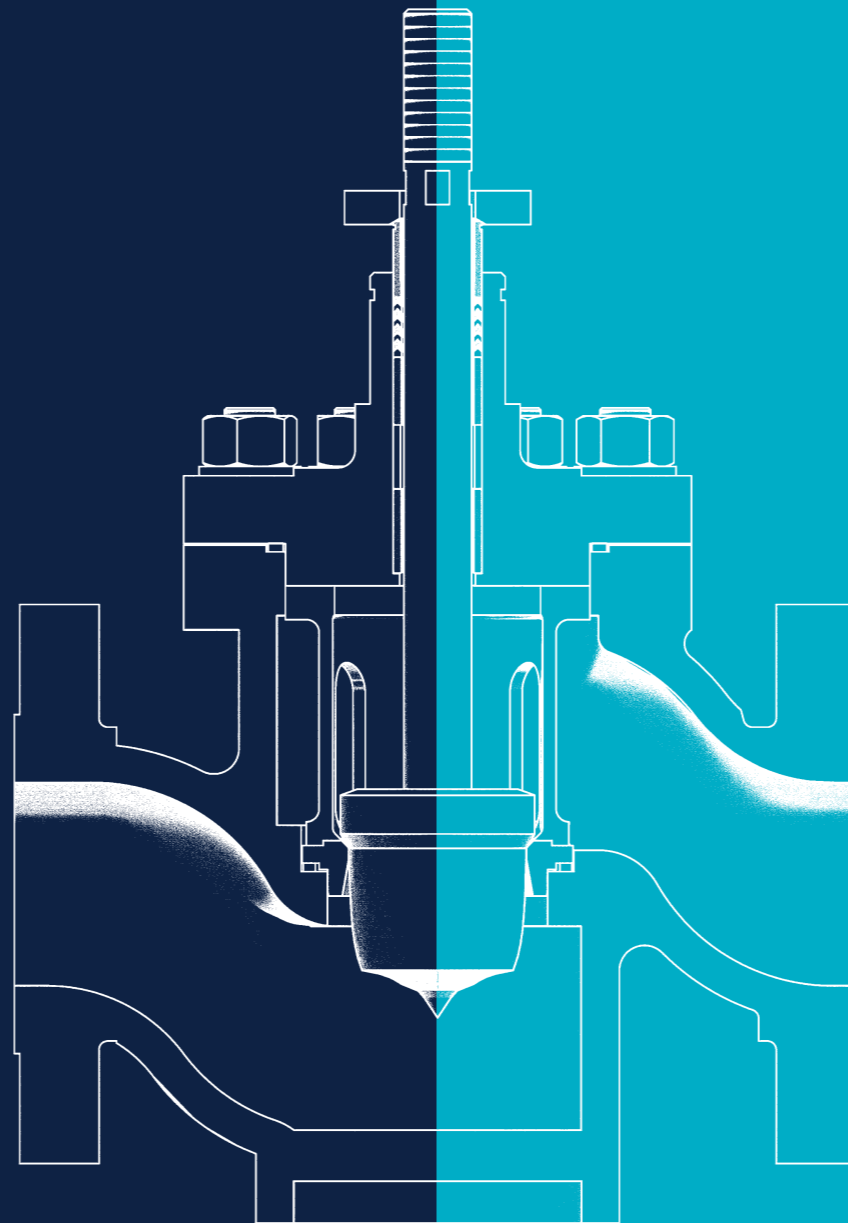

5000 SERIES

The 5000 Series range of globe valves benefits from more than 40 years of infield experience to deliver high performance, easily maintained, reliable and high quality valves for the most severe applications.

The wide choice of materials used for manufacture offers bespoke application solutions, while the smooth body flow path reduces turbulence, minimising the effects of erosion and noise.



Engineering data

The 5000 Series range of valves provides a cost effective, reliable and easily maintained control valve capable of working in the most rigorous environments.

Design features

- ✓ Smooth profile cast globe, angle and three way body construction
- ✓ Quick-change trim as standard with screwed-in seat option
- ✓ Wide choice of trim sizes available with low noise and anti-cavitation options
- ✓ Robust parts for trouble free service and low maintenance costs
- ✓ Inherently characterised trims available in linear, bi-linear, equal percentage or semi-throttle
- ✓ Substantial guiding
- ✓ Wide choice of packing systems including low fugitive emission designs
- ✓ Integral plug stem construction option
- ✓ Both balanced and unbalanced trim designs with soft seat insert options

Performance benefits

- ✓ Top-entry servicing with easily maintained trimsets
- ✓ Reduced inspection and maintenance costs
- ✓ Trims are easily installed
- ✓ Excellent flow capacity and control rangeability
- ✓ Design reduces potential erosion and noise issues
- ✓ Reliable leakage performance. Bubble tight shut off available
- ✓ High interchangeability between sizes and other products
- ✓ Rigorous in-field testing
- ✓ Manufactured to ISO 29001 certification and compliant with PED requirements
- ✓ Low actuating forces required with balanced trim styles

The quick-change trim option allows easily accessible trim components to minimise fitting and replacement times.

Stem-guided contoured trim in both balanced and unbalanced configuration gives excellent rigidity and resistance to vibration and service wear. The valve is designed to accommodate other products within the Severn range, for example, MLT (multi-labyrinth trim) CC (Concentric Cages) low noise, and anti-cavitation trims.

The vast array of repair intelligence has been utilized to develop the most robust method of design. The 5000 Series utilizes the latest trim technology from the simple contoured plug through to multi labyrinth trims paving the way for future upgrades if required. The robust guiding of the 5000 Series valves provides excellent rigidity and resistance to vibration regardless of the valves configuration, meaning increased service intervals and reduced downtime.

Engineering data (continued)

End connection sizes/types

1/2in (12mm) – 36in (900mm). Integral or Separable Flanges, Screwed, Butt or Socket weld ends. For other styles please contact us.

Valve body ratings

ASME 150 – 4500
EN 1092 PN 10 to PN 400
API 5000 – API 15000

Body configurations

Globe, angle and three way valves.

Body face to face dimensions

ANSI/ISA 75.08 up to 10in and class 600.
12in and above as per Severn standard.

Bonnet styles

Standard, normalising, cryogenic and bellows seal. For other styles please contact us.

Construction materials

A wide range of standard materials are available for both the valve pressure containing parts and trim, including carbon and stainless steel, duplex/super duplex and high nickel alloys. Stellite, and other hard facings/coatings are available. We also provide a range of tungsten carbide and ceramic material options for severe service trims. For further details on materials please contact us.

Paint

A wide range of paint finishes are available including enamel, alkyd gloss and various epoxy finishes.

Clean build

Severn maintains high clean build standards-utilising clean build areas including Oxygen clean and a Ultra High Purity clean room.

Inspection and testing

Severn undertakes the highest levels of inspection and testing which meet international and customer requirements.

Actuation

We offer a wide range of actuators including the P-Series Linear spring opposed pneumatic cylinders and W-Series diaphragm-spring pneumatic actuators. In addition electric, hydraulic, spring & diaphragm electro hydraulic actuators and manually operated versions are available.

Instruments

A wide range of control instruments are available from Severn including positioners, air-filter regulators, volume boosters, solenoid valves, and lock-up valves.

Standard bonnet packing

PTFE Chevrons
PTFE Braided Rope
Die Formed Graphite
Graphite Braided Rope
ISO 15848-1 & ISO 15848-2 compliant

Trim options

Stem-guided contoured trim, "Quick change," Concentric Cage(s), Multi-labyrinth trim, Multi-step, Micro Spline and Trickle Trim. A vast array of alternative trims are available depending on the application.

Inherent trim characteristics

Linear, bi-linear, equal percentage or semi-throttle.

Plug options

Balanced, Unbalanced
Cage/Top guided
Hard faced or solid hard plugs
Soft seat option
Full thickness tungsten carbide components

Plug/Seat leakage class

FCI 70-2 – Up to Class VI
ISO 60534-4 – Up to to Class VI



5000 Series Control Valve

Valve body style option

The 5000 Series valve is available in three basic body styles – globe, angle or three way. Apart from the valve bodies, many parts are interchangeable. The angle pattern has an optional venturi seat which provides additional protection for the valve outlet.

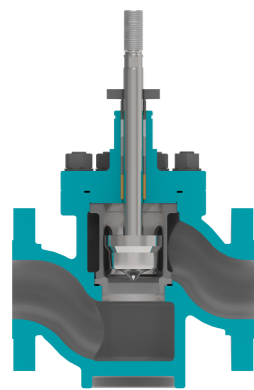

Globe body

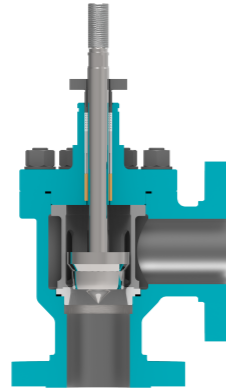

Angle body

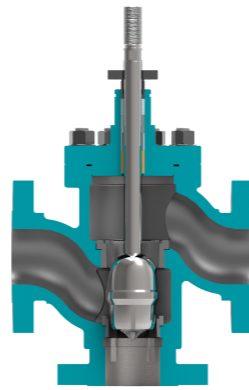

Three way body

Bonnet options

Usually constructed in the same material as the valve body, selection of the bonnet design is undertaken on the basis of both the operating temperature range and the fluid media handled. A temperature range of – 190 °C to 580 °C is achievable. For hazardous/lethal media a bellows seal bonnet is recommended.

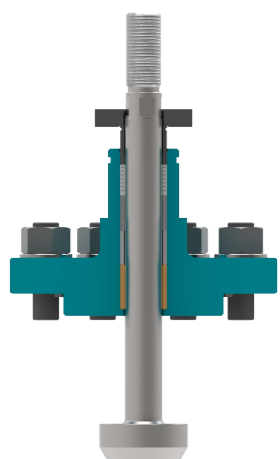

Standard bonnet

This enables the formation of a deep packing box together with a long guide housing, thereby providing a robust and vibration-resistant assembly. Teflon rings are the standard packing up to 250 °C.

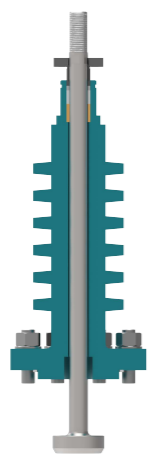

Normalising bonnet

Protects the packing from excessive heat or cold, which may adversely affect valve, or packing performance. Application temperature range depends upon the valve and bonnet construction materials.



Bellows seal bonnet

Provides a positive metallic gland seal, within the rated pressure and temperature of the bellows material selected. Typically used on hazardous/lethal service. An auxiliary packing box in the upper bonnet serves as a back-up seal in the unlikely event of a bellows failure.

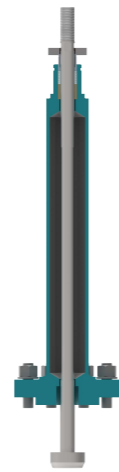

Cryogenic bonnet

Allows stagnated moderate temperature gas to form within the bonnet which then protects the packing from the extremes of temperature produced by the line fluid. Normally constructed in stainless steel it operates to –196 °C.

Standard trim options available

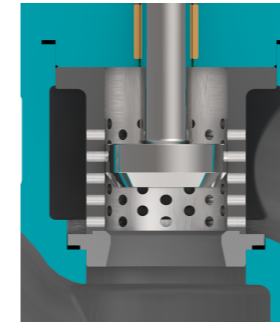

Unbalanced trim

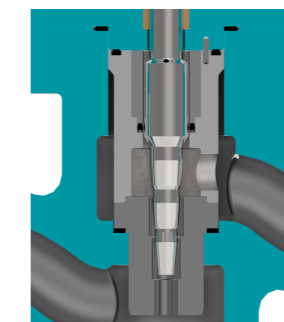

Balanced trim

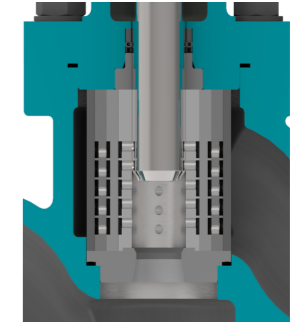

Hard facing options

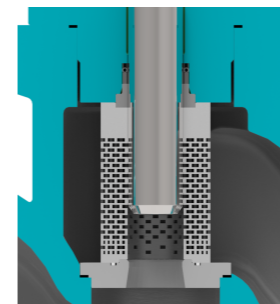

Soft seat insert

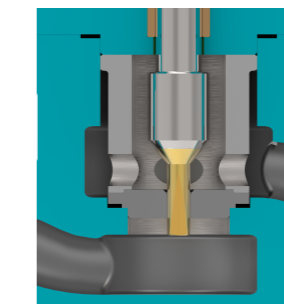

Spline

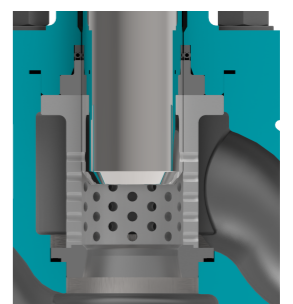

CC cage trim

Standard duty – normal flows

“Quick Change” balanced and unbalanced trim are available. Suitable for modulating and on / off duty.

Valve size options

Standard range up to 36in. For large sizes please contact us.

Plug options

Balanced and unbalanced, contoured metal seated. Resilient / soft seat insert option available.

Characteristics available

Equal %, Linear or Semi-throttle. Others on request.

Direction of flow

Either direction – dependant upon application.

Hard trim options

Hard coatings / facings – seat area or full contour. Solid – seat and / or plug. Wide choice of materials depends on service conditions.

Soft / resilient seating

Soft seat insert fully supported and integral within the seat.

Standard duty – low flows

The Trickle Trim / Micro Spline range provides for high rangeability and control of low flow rates.

Plug options

Unbalanced with metal to metal seating faces.

Direction of flow

Either direction – dependant upon application.

Guiding

Top guided
LRP
LMST
DPMST
Multispline

Severe service duties

Single / Multiple Concentric Cage (CC) trims are available for higher pressure drop applications to prevent the onset of cavitation and to reduce noise levels. MLT (Multi-Labyrinth trim) are also available for the most severe service.

Trim design

Severn's valve trim designs, engineered for specific applications, may include a combination of

- ✔ Multi-stage pressure reduction stages
- ✔ Tortuous paths – as the fluid changes direction, energy is dissipated
- ✔ Flow impingement of one flow path onto another also causes energy loss

Through our World Class Engineering Intelligence, Severn can provide the ideal trim solution having considered the process control conditions and the preferred flow direction, as well as initial and life cycle costs.

There is no one common definition for a 'Severe Service' trim design

A trim capable of offering a high number of flow passages and discrete pressure let down stages to the process fluid, Severn have **5 trim designs** that develop this type of flow model.

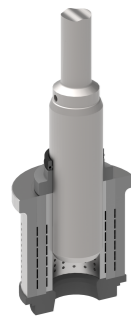

CC Cage Trim

- ✔ Utilises a predetermined number of drilled cages to create a complex 'multistage pressure letdown' flow-path to the process fluid
- ✔ The holes in the cages are arranged to create a 90 degree turn at each point of impingement
- ✔ Up to 4 cages ('4CC') can be offered to develop up to 9 stages of pressure let down
- ✔ Can be manufactured in any combination of material to meet requirements of specification



CCD Disk Stack

- ✔ Built from individual disks produced in a stack form
- ✔ Originally developed for production chokes
- ✔ Manufactured from solid tungsten carbide
- ✔ Available in a selection of metallic materials for applications containing debris
- ✔ Each disk is produced with a complex pattern of machine or 3D printed passages and turns
- ✔ Pattern of passages is set to create a complex flow passage to process fluid

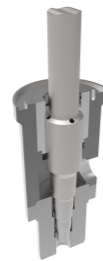

LRP

- ✔ Multiple stages of pressure let-down
- ✔ Shallow impingement angle ideal for contaminated service
- ✔ Multiple material options

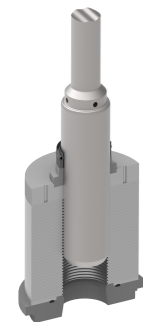

MLT Disk Stack

- ✔ Built from individual disks produced in a stack form
- ✔ Each disk produced with a complex pattern of 'laser cut' windows
- ✔ Creates a complex flow to the process fluid
- ✔ Individual plates are 'vacuum brazed' to form a single component
- ✔ Allows development of up to 64 stages of pressure letdown



DPMST / LMST

- ✔ Low flow trims with precise control
- ✔ Multiple stages of pressure let-down
- ✔ Hardened materials for high pressure differentials

Bespoke Solutions

Using a single approach on 'Severe Service' duties would be a serious mistake. Severn manufactures a large number of other trim designs used for 'Severe Service' applications. These trims vary in design from those identified here and in many cases they have been developed to address a particular type of 'Severe Service' application.

Flow coefficients (Cv)

The Cv values detailed in the tables are at the maximum rated travel and stated in US units. The figures by definition are related to the flow of water (Specific gravity = 1) in US Gallons per minute with a pressure drop 1psi.

The Cv values mentioned below are normal. Please contact us for process Cv over 80% of the rated Cv. We have a wide range of capacities depending on trim and service conditions.

Table 1: Trickle trims

Valve size		Available trim Cv							
in	mm	ASME 150, 300, 600							
1/2	12	0.01	0.05	0.1	0.15	0.25	0.50	0.95	1.45
3/4	20	0.01	0.05	0.1	0.15	0.25	0.50	0.95	1.45
1	25	0.01	0.05	0.1	0.15	0.25	0.50	0.95	1.45

Note: These trims are available with only linear flow/lift characteristics

Table 2: Contoured and multi-step trims

Valve size		Available trim Cv														900-1500	2500
in	mm	ASME 150, 300, 600															
1/2	12	1	1.5	2.5													
2	50	1	1.5	2.5	4	6	9	12	16	20	25	30	35	46		36	25
4	100								25	46	75	110	135	195		135	110

Note: Multi-step trim options are indicated in green. For other options please contact us.

Table 3: Single stage cage trims

Valve size		Available trim Cv														900-1500	2500
in	mm	ASME 150, 300, 600															
1	25	2	4	6	9	12										8	8
6	150							130	200	240	300	350				300	240
12	300										600	800	1250			950	800
18	450												1830	2300	2800	1890	
24	600												3000	3500	4700	3350	

Note: For valve and trim sizes outside this range please contact us.

Standard dimensions & weights

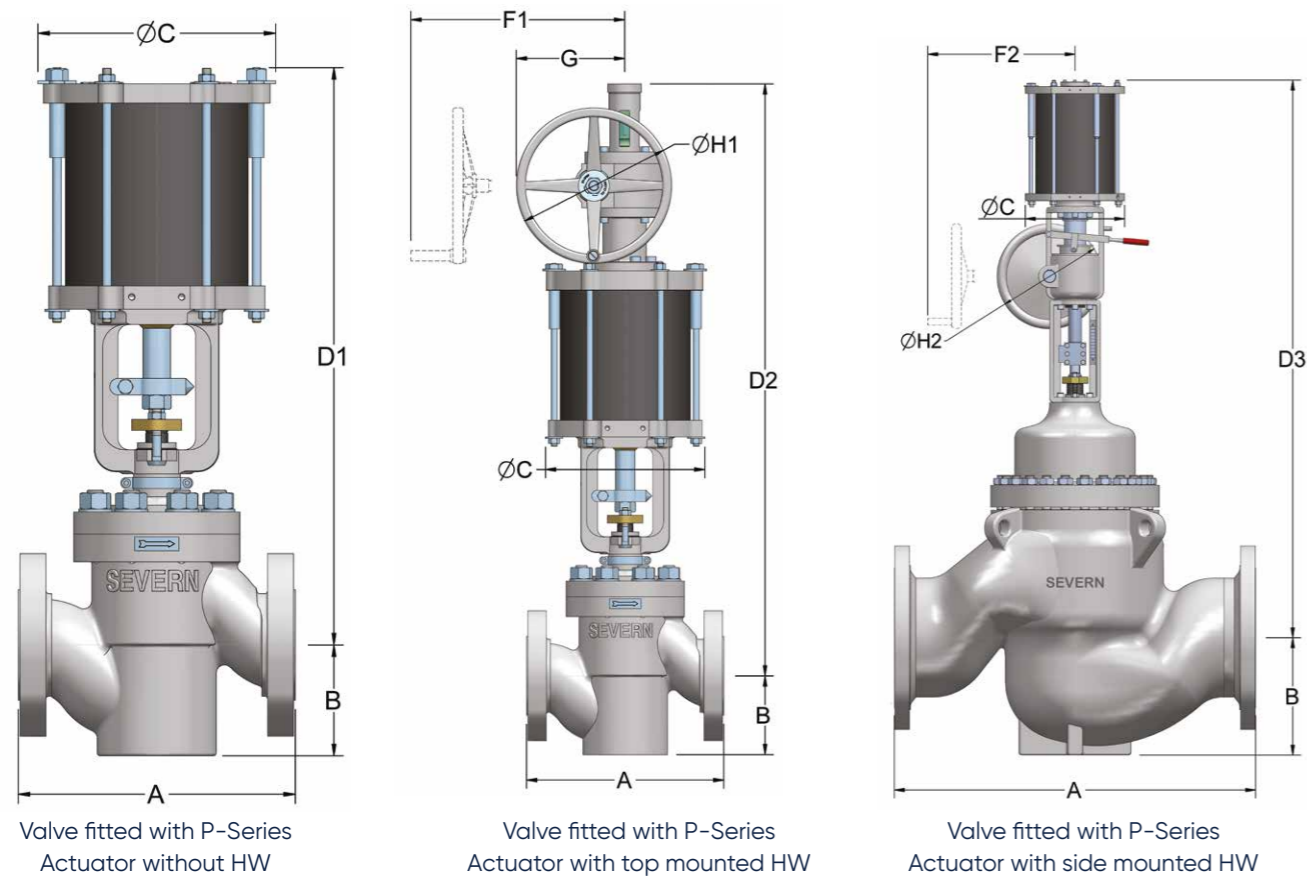

Valve fitted with P-Series Actuator without HW

Valve fitted with P-Series Actuator with top mounted HW

Valve fitted with P-Series Actuator with side mounted HW

Table 4: Dimensions of standard 5000 unbalanced valve with P-Series Actuator

Valve	DIM "A"			DIM	DIM	DIM	DIM	DIM	DIM	DIM	DIM	DIM	DIM	ACT	Approx. weight			
Size	150#	300#	600#	"B"	"C"	"D1"	"E"	"D2"	"G"	"F1"	"H1"	"D3"	"F2"	"H2"	Size	150#	300#	600#
In	Standard dimensions					Without HW		Top mounted HW			Side mounted HW				kg	kg	kg	
1	184	197	210	67	210	473	370	750	156	211	230	-	-	-	A	30	30	31
1.5	222	235	251	83	210	520	370	795	156	211	230	-	-	-	A	40	40	41
1.5	222	235	251	83	260	625	485	995	203	229	305	-	-	-	B	48	48	52
2	254	267	286	108	210	520	370	795	156	211	230	-	-	-	A	53	53	55
2	254	267	286	108	260	643	485	1013	203	229	305	-	-	-	B	60	60	62
3	298	318	337	127	260	668	485	1038	203	229	305	-	-	-	B	92	92	110
3	298	318	337	127	390	784	605	1245	267	257	380	-	-	-	C	98	98	116
4	353	368	394	127	260	677	485	1047	203	229	305	-	-	-	B	122	122	136
4	353	368	394	127	390	797	605	1257	267	257	380	-	-	-	C	128	128	142
6	451	473	508	171	390	857	605	1317	267	257	380	-	-	-	C	260	260	282
6	451	473	508	171	390	1292	1013	-	-	-	-	1667	220	380	C	315	315	345
6	451	473	508	171	530	1333	1054	-	-	-	-	1703	220	380	D	405	405	434
8	543	568	610	210	390	1311	1013	-	-	-	-	1686	220	380	C	392	405	452
8	543	568	610	210	530	1352	1054	-	-	-	-	1720	220	380	D	479	479	539
10	673	708	-	228	390	1343	1013	-	-	-	-	1718	220	380	C	577	577	-
10	-	-	752	254	390	1343	1013	-	-	-	-	1718	220	380	C	-	-	625
10	673	708	-	210	530	1384	1054	-	-	-	-	1759	220	380	D	664	664	-
10	-	-	752	254	530	1384	1054	-	-	-	-	1759	220	380	D	-	-	712

Table 5: Dimensions of standard 5000 balanced valve with P-Series Actuator

Valve	DIM "A"			DIMN	DIMN	DIMN	DIMN	DIMN	DIMN	DIMN	DIMN	ACT	Approx. weight		
Size	150#	300#	600#	"B"	"C"	"D1"	"E"	"D2"	"G"	"F1"	"H1"	Size	150#	300#	600#
In	Standard dimensions					Without HW		Top mounted HW					kg	kg	kg
2	254	267	286	108	210	564	370	840	156	211	230	A	58	58	60
3	298	318	337	127	390	883	605	1343	267	257	380	C	112	112	126
4	352	368	394	127	390	889	605	1350	267	257	380	C	138	138	152
6	451	473	508	171	390	949	605	1410	267	257	380	C	285	285	307

Valve	DIM "A"			DIMN	DIMN	DIMN	DIMN	DIMN	DIMN	DIMN	ACT	Approx. weight		
Size	150#	300#	600#	"B"	"C"	"D1"	"E"	"D3"	"F2"	"H2"	Size	150#	300#	600#
In	Standard dimensions					Without HW		Top mounted HW				kg	kg	kg
6	451	473	508	171	390	1442	1013	1817	220	380	C	338	338	360
6	451	473	508	171	530	1483	1054	1858	220	380	D	425	425	447
8	543	568	610	210	390	1506	1013	1881	220	380	C	439	439	452
8	543	568	610	210	530	1548	1054	1923	220	380	D	526	526	539
10	673	708	-	229	390	1535	1013	1911	220	380	C	612	612	-
10	-	-	752	254	390	1535	1013	1911	220	380	C	-	-	712
10	673	708	-	229	530	1577	1054	1952	220	380	D	699	699	-
10	-	-	752	254	530	1577	1054	1952	220	380	D	-	-	799
12	838	838	838	320	390	1553	1013	1928	220	380	C	1107	1107	1217
12	838	838	838	320	390	1578	1038	1953	220	380	C	1112	1112	1222
12	838	838	838	320	530	1594	1054	1969	220	380	D	1194	1194	1304
12	838	838	838	320	530	1635	1095	2010	220	380	D	1199	1199	1309
14	1219	1219	1219	360	390	1615	1038	1990	220	380	C	1740	1740	1889
14	1219	1219	1219	360	530	1672	1095	2047	220	380	D	1827	1827	1976
16	1168	1168	1207	429	390	1800	1038	2175	220	380	C	2320	2320	2470
16	1168	1168	1207	429	390	2105	1343	2844	220	380	C	2330	2330	2480
16	1168	1168	1207	429	530	2170	1408	2884	220	380	D	2420	2420	2570
18	1626	1626	1676	485	390	2423	1343	3163	220	380	C	3695	3695	3800
18	1626	1626	1676	485	530	2488	1408	3202	220	380	D	3785	3785	3890
20	1800	1800	1800	584	390	2512	1343	3252	220	380	C	5205	5205	5245
20	1800	1800	1800	584	530	2577	1408	3291	220	380	D	5295	5295	5335
24	1800	1800	1800	584	390	2512	1343	3252	220	380	C	5305	5305	5345
24	1800	1800	1800	584	530	2577	1408	3291	220	380	D	5395	5395	5435

Note:

- 1 For other sizes please contact us
- 2 For dimensions where unit is not indicated consider the unit as "mm"
- 3 Dimensions shown may vary depend upon options selected on actual product

Custom F-F dimensions

Severn are experts in providing flexible, technical solutions to ensure we exceed our customers specifications.



Engineering
Excellence

Gloucester UK (HQ)

Olympus Park,
Quedgeley,
Gloucester, GL2 4NF.

T: +44 (0)845 223 2040
E: sales@severnvalve.com

Severn India (Unit 1)

F96 & F97, SIPCOT Industrial Park,
Irrungattukottai, Chennai,
Tamilnadu, India - 602 117.

T: +91 44 4710 4200
E: sales@severnvalve.com

Severn India (Unit 2)

A-50, SIPCOT Industrial Growth
Centre, Oragadam, Chennai -
Tamilnadu, India - 602105

T: + 044 67123200
E: sales@severnvalve.com

Centre of Engineering Excellence

Crossley Mills, Dean Clough,
Halifax, HX3 5AX

T: +44 (0)845 6070 710
E: sales@severnvalve.com

